

STARREG 5400 SERIES

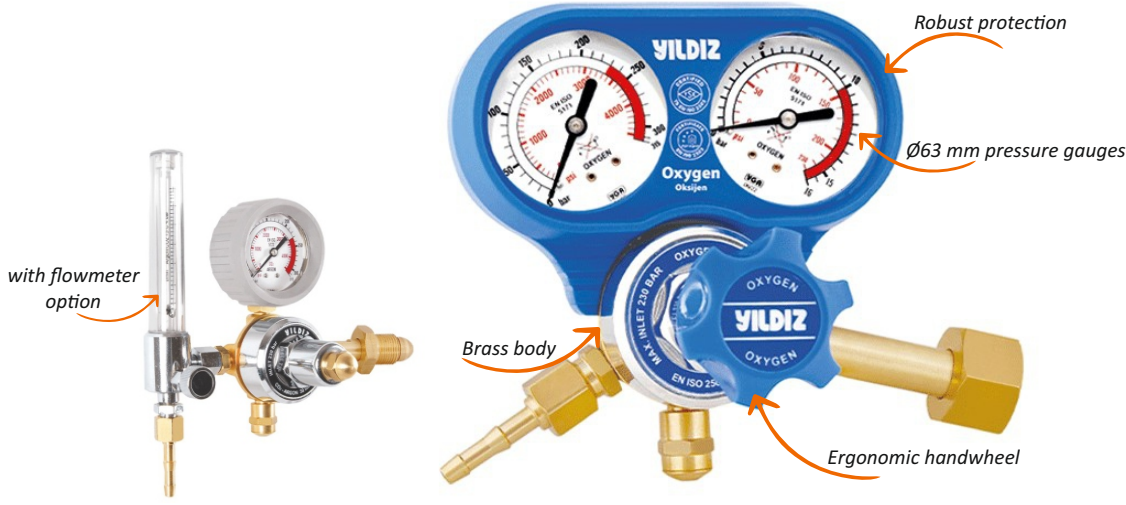

EN ISO 2503



5400 series regulators has been designed for use with all common technical gases up to 300 bar cylinder pressure.

Features

- Designed following ISO 2503
- Robust protection
- Stainless steel filter
- Ergonomic handwheel
- Body machined directly from brass bar
- EPDM and NBR diaphragm
- Integrated overpressure relief valve

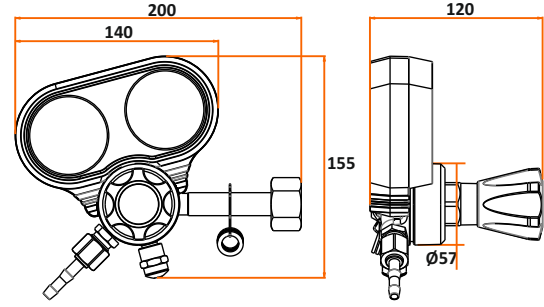

Refence Standards

- ISO 2503** : Gas welding equipment - Pressure regulators and pressure regulators with flow-metering devices for gas cylinders used in welding, cutting and allied processes up to 300 bar (30 MPa)
- ISO 5171** : Gas welding equipment – Pressure gauges used in welding, cutting and allied processes
- ISO 9539** : Gas welding equipment - Materials for equipment used in gas welding, cutting and allied processes
- ISO 9090** : Gas tightness of equipment for gas welding and allied processes.

Technical Specifications

Gas Type	Inlet Pressure	Outlet Pressure	Flow Rate(Qmin)	Temperature Range
Oxygen	230 / 300 bar	10 bar	30 m ³ /h	From -20°C to 60°C
Acetylene	25 bar	1,5 bar	5 m ³ /h	
Propane	25 bar	1,5 / 4 bar	5 m ³ /h	
Nitrogen	230 / 300 bar	4 / 10 bar	30 m ³ /h	
Argon	230 / 300 bar	21 l/min / 4 bar / 10 bar	-	
CO ₂	230 / 300 bar	21 l/min / 4 bar / 10 bar	-	
Helium	230 / 300 bar	10 bar	30 m ³ /h	
Hydrogen	230 / 300 bar	10 bar	30 m ³ /h	
Natural Gas	230 / 300 bar	10 bar	30 m ³ /h	

*The Cylinder Connection is Made In Accordance with Each Country and Standard

World of Welders

YILDIZ GAZ ARMATÜRLERİ SANAYİ VE TİCARET A.Ş.

www.yildizgaz.com.tr

STARREG 5400 SERIES

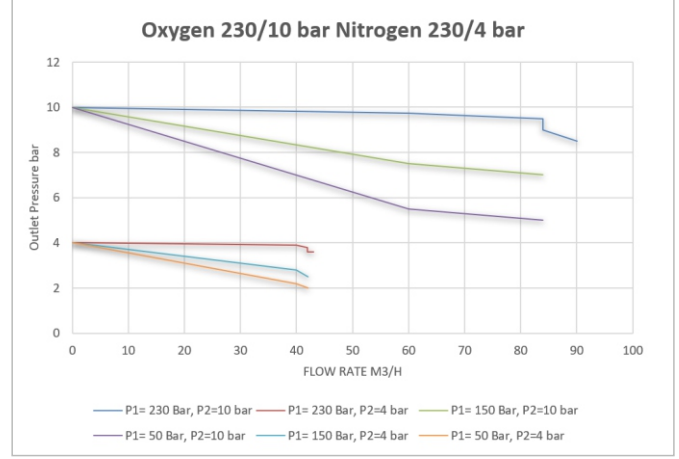
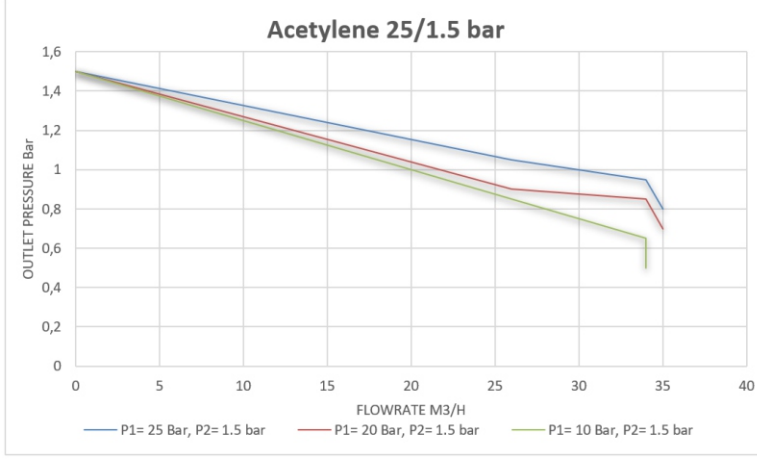

Flow Rates



Certificate

- TSE (Turkish Standards Institution)
- APRAGAZ (Certificate Authority Located in Belgium)
- CE (Conformity Europe)



		
<p>APPROVAL CERTIFICATE</p> <p>In accordance with the European standard EN ISO 2503 - July 2009 • Gas welding equipment - Pressure regulators for gas cylinders used in welding, cutting and allied processes up to 300 bar</p>		
<p>Manufacturer: YILDIZ GAZ ARMATÜRLERİ</p> <p>Name: YILDIZ GAZ ARMATÜRLERİ</p> <p>Address: Akbaşgaz Mah. 2. Cad. 137 Sok. N° 55 34222 Esenyurt - İSTANBUL (TURKEY)</p>		<p>Certificate N°: 04TRN02-1-REV 0</p>
<p>Concerted equipment: Pressure regulator for gas cylinders</p> <p>TYPE: Series 5400</p> <p>Models references: - S401 for oxygen with a maximum working pressure of 300 bar (Class 3) - S401 for oxygen with a maximum working pressure of 230 bar (Class 3) - S402 for acetylene without safety relief valve (Class 2) - S403 for CO₂/Ar with a max. inlet pressure of 230 bar and a gas flow rate of 18 l/min</p>		
		
<p>The manufacturer is allowed to fix the Mark « EN ISO 2503 » to approved equipments described here above. The results of the approval tests according to the requirements of the European standard EN ISO 2503 are described in our reports referred: L25410, L25411, L25413 and L25414.</p> <p>NOTES: The approved pressure regulators will be clearly and permanently marked on the regulator body with the following information: - The number of the standard EN ISO 2503 - The name or trade mark of the manufacturer and/or distributor - The pressure regulator class and G - The rated inlet pressure, p₁ - The name of the gas intended for use</p> <p>The manufacturer is allowed to put these marks only on the approved models. Each modification to the prototypes must be reported to us in order to reapprove if the present certificate remains valid.</p> <p>The approval is valid until October 2024.</p> <p>Date: 30/10/2014 Name: Ch. Lepelt Position: p.a. General Manager</p> <p>Notified Body Stamp: APRAGAZ Belgium Inspecting Authority</p> <p>Notified Body Reference: L4603293</p>		

	
<p>TÜRK STANDARLARI ENSTİTÜSÜ TÜRK STANDARLARINA UYGUNLUK BELGESİ TÜRKISH STANDARDS INSTITUTION CERTIFICATE OF CONFORMITY TO TURKISH STANDARDS</p>	
<p>Belge Numarası: 000145-TSE-02/02</p> <p>Referans Numarası: 23.11.2007</p> <p>Belgeleme Tarihi: 12.12.2023</p> <p>Belgeleme Yeri: YILDIZ GAZ ARMATÜRLERİ SANAYİ VE TİCARET ANONİM ŞİRKETİ</p> <p>Belge Sahibi Kuruluşun Adı: YILDIZ GAZ ARMATÜRLERİ SANAYİ VE TİCARET ANONİM ŞİRKETİ</p> <p>Belge Sahibi Kuruluşun Adresi: AKBAŞGAZ MAHALLESİ 137. SOKAK NO:5 ESENYURT İSTANBUL/TÜRKİYE</p> <p>Üretim Yeri Adı: YILDIZ GAZ ARMATÜRLERİ SANAYİ VE TİCARET ANONİM ŞİRKETİ</p> <p>Üretim Yeri Adresi: AKBAŞGAZ MAHALLESİ 137. SOKAK NO:5 ESENYURT İSTANBUL/TÜRKİYE</p> <p>İptal Edilen Belge Numarası (Var): 000145-TSE-02/01</p> <p>Tescilli Ticarî Markası: YILDIZ</p> <p>İlgili Türk Standardı: TS EN ISO 2503 / 13.01.2011</p> <p>Belge Kapsamı: BASINÇ REGÜLATÖRLERİ (SİVİL)</p> <p>Belge Kapsamı: BASINÇ REGÜLATÖRLERİ (SİVİL) SERİSİ</p> <p>Belge Kapsamı: ÇİFTLİNE BASINÇ REGÜLATÖRLERİ (GRİS) BASINÇI 230 BAR SİNİF 3</p> <p>Belge Kapsamı: AÇIKLİNE BASINÇ REGÜLATÖRLERİ (GRİS) BASINÇI 230 BAR SİNİF 2</p> <p>Belge Kapsamı: AÇIKLİNE BASINÇ REGÜLATÖRLERİ (GRİS) BASINÇI 230 BAR SİNİF 3</p> <p>Belge Kapsamı: ÇİFTLİNE BASINÇ REGÜLATÖRLERİ (GRİS) BASINÇI 230 BAR SİNİF 2</p> <p>Belge Kapsamı: ÇİFTLİNE BASINÇ REGÜLATÖRLERİ (GRİS) BASINÇI 230 BAR SİNİF 3</p> <p>Belge Kapsamı: ÇİFTLİNE BASINÇ REGÜLATÖRLERİ (GRİS) BASINÇI 230 BAR SİNİF 2</p> <p>Belge Kapsamı: ÇİFTLİNE BASINÇ REGÜLATÖRLERİ (GRİS) BASINÇI 230 BAR SİNİF 3</p>	
<p>Belge Sahibi Kuruluşun Adı: YILDIZ GAZ ARMATÜRLERİ SANAYİ VE TİCARET ANONİM ŞİRKETİ</p> <p>Belge Sahibi Kuruluşun Adresi: AKBAŞGAZ MAHALLESİ 137. SOKAK NO:5 ESENYURT İSTANBUL/TÜRKİYE</p> <p>Üretim Yeri Adı: YILDIZ GAZ ARMATÜRLERİ SANAYİ VE TİCARET ANONİM ŞİRKETİ</p> <p>Üretim Yeri Adresi: AKBAŞGAZ MAHALLESİ 137. SOKAK NO:5 ESENYURT İSTANBUL/TÜRKİYE</p> <p>İptal Edilen Belge Numarası (Var): 000145-TSE-02/01</p> <p>Tescilli Ticarî Markası: YILDIZ</p> <p>İlgili Türk Standardı: TS EN ISO 2503 / 13.01.2011</p> <p>Belge Kapsamı: BASINÇ REGÜLATÖRLERİ (SİVİL)</p> <p>Belge Kapsamı: BASINÇ REGÜLATÖRLERİ (SİVİL) SERİSİ</p> <p>Belge Kapsamı: ÇİFTLİNE BASINÇ REGÜLATÖRLERİ (GRİS) BASINÇI 230 BAR SİNİF 3</p> <p>Belge Kapsamı: AÇIKLİNE BASINÇ REGÜLATÖRLERİ (GRİS) BASINÇI 230 BAR SİNİF 2</p> <p>Belge Kapsamı: AÇIKLİNE BASINÇ REGÜLATÖRLERİ (GRİS) BASINÇI 230 BAR SİNİF 3</p> <p>Belge Kapsamı: ÇİFTLİNE BASINÇ REGÜLATÖRLERİ (GRİS) BASINÇI 230 BAR SİNİF 2</p> <p>Belge Kapsamı: ÇİFTLİNE BASINÇ REGÜLATÖRLERİ (GRİS) BASINÇI 230 BAR SİNİF 3</p>	
<p>Belge Sahibi Kuruluşun Adı: YILDIZ GAZ ARMATÜRLERİ SANAYİ VE TİCARET ANONİM ŞİRKETİ</p> <p>Belge Sahibi Kuruluşun Adresi: AKBAŞGAZ MAHALLESİ 137. SOKAK NO:5 ESENYURT İSTANBUL/TÜRKİYE</p> <p>Üretim Yeri Adı: YILDIZ GAZ ARMATÜRLERİ SANAYİ VE TİCARET ANONİM ŞİRKETİ</p> <p>Üretim Yeri Adresi: AKBAŞGAZ MAHALLESİ 137. SOKAK NO:5 ESENYURT İSTANBUL/TÜRKİYE</p> <p>İptal Edilen Belge Numarası (Var): 000145-TSE-02/01</p> <p>Tescilli Ticarî Markası: YILDIZ</p> <p>İlgili Türk Standardı: TS EN ISO 2503 / 13.01.2011</p> <p>Belge Kapsamı: BASINÇ REGÜLATÖRLERİ (SİVİL)</p> <p>Belge Kapsamı: BASINÇ REGÜLATÖRLERİ (SİVİL) SERİSİ</p> <p>Belge Kapsamı: ÇİFTLİNE BASINÇ REGÜLATÖRLERİ (GRİS) BASINÇI 230 BAR SİNİF 3</p> <p>Belge Kapsamı: AÇIKLİNE BASINÇ REGÜLATÖRLERİ (GRİS) BASINÇI 230 BAR SİNİF 2</p> <p>Belge Kapsamı: AÇIKLİNE BASINÇ REGÜLATÖRLERİ (GRİS) BASINÇI 230 BAR SİNİF 3</p> <p>Belge Kapsamı: ÇİFTLİNE BASINÇ REGÜLATÖRLERİ (GRİS) BASINÇI 230 BAR SİNİF 2</p> <p>Belge Kapsamı: ÇİFTLİNE BASINÇ REGÜLATÖRLERİ (GRİS) BASINÇI 230 BAR SİNİF 3</p>	

	
<p>CERTIFICATE</p> <p>Certificate registration number: ZST/SV/WE/3145</p> <p>The notified body TÜV AUSTRIA SERVICES GMBH (identification number 0408) certifies, that the manufacturer Yıldız Gaz Armatürleri SAN. TIC. A.Ş. Akbaşgaz Mah. 137. Sok. No:5 34222 Esenyurt - İstanbul / TÜRKİYE operates a quality assurance system for design, manufacture, final inspection and testing according to Annex III of the Pressure Equipment Directive 2014/68/EU which is subject to surveillance by TÜV AUSTRIA SERVICES GMBH and is therefore authorized to apply the following conformity assessment procedures according Pressure Equipment Directive 2014/68/EU: Module E, E1, D, D1, H, H1</p> <p>Scope: Check Valve, Flashback Arrestor, Gas Line Filters, Pressure Regulators, Safety Relief Valves</p> <p>Based on our audit according Annex III of the Pressure Equipment Directive 2014/68/EU carried out on 17-18.09.2019 we certify compliance with the requirements.</p> <p>Results of the audit are recorded in audit report 19-15-1379-2019-PED-Modul H1-018, dated 18.09.2019.</p> <p>Pressure equipment and assemblies within the scope of this certificate shall carry the marking as illustrated:</p> <p>CE 0408</p> <p>This certificate is valid from 04.10.2019 to 03.10.2022, provided that the terms and conditions of the agreement with the notified body are met.</p> <p>Vienna, 04.10.2019</p> <p>TÜV AUSTRIA SERVICES GMBH Notified body 0408</p> <p>Di Martin Schwarz Notified body 0408</p>	

Cautions

Without our company's control or information, any change shouldn't have done on pressure regulator. Please read user manual carefully before using the product.